

Universal:

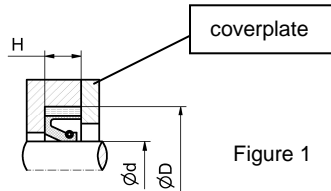

Figure 1

**01 (endless)**  
**07 (split)**

Universal with grooves for lubrication:

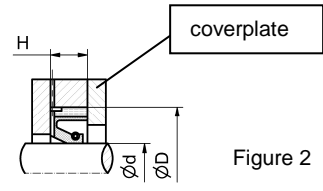

Figure 2

**02 (endless)**  
**08 (split)**

high pressure:

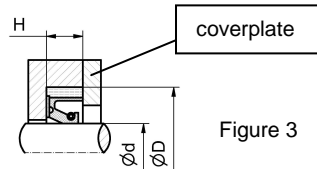

Figure 3

**10 (endless)**

high pressure:

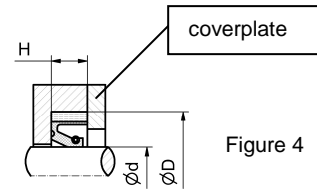

Figure 4

**11 (endless)**

lubrication: requested! above approx 0,2m/s  
media to be sealed: oil, grease, water, slurry, suspension with hard particles

model			radial runout mm max.	operating pressure max. Bar / MPa	
<b>01</b>	<b>02</b>	<b>endless</b>	1,5	1	0,1
<b>07</b>	<b>08</b>	<b>split</b>	1,5	low grade	low grade
<b>04</b>		<b>endless</b>	1,5	1	0,1
<b>10</b>		<b>endless</b>	0,5	50	5
<b>11</b>		<b>endless</b>	0,7	50	5

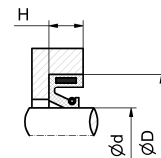

Figure 5

selfretaining:  
**04 (endless)**

material:	temperature °C		speed m/s max.		chemical resistance
	min.	max.			
<b>FDI<sup>®</sup> 1002</b>	-40	+120	15		as NBR
<b>FDI<sup>®</sup> 2002</b>	-40	+170	25		as HNBR
<b>FDI<sup>®</sup> 3002</b>	-30	+200	30		as FPM

The indicated data are limits and can't be combined !

Ø range of d (mm)	cross section D-d 2 H		radial runout mm max.	axial movement mm unlimited
	< 50	11	10	0,6
> 50 - 100	16	12,5	0,75	∞
> 100 - 250	20	16	0,9	∞
> 250 - 400	22	20	1,0	∞
> 400 - 600	25	22	1,2	∞
> 600	32	25	1,5	∞

The data shown above is based on long lasting experience in the manufacturing and use of sealing elements. As there are many unknown possible parameters and conditions in practice, which may limit standard performance, it is requested that the user runs practical tests. Except as expressly stated, Friedrich's liability, expressed or implied, is limited to the published selling price of our defective item.

**FDI<sup>®</sup>** and **FDI-DICHTUNGEN<sup>®</sup>** are registered trademarks of Friedrich GmbH.

**FRIEDRICH** GmbH - Höffgeschowweg 2 - 47807 Krefeld, Germany - [www.fdi-dichtungen.com](http://www.fdi-dichtungen.com)  
Tel.: ++49-(0)2151-835770 - Fax: ++49-(0)2151-835777 - e-mail: [info@fdi-dichtungen.com](mailto:info@fdi-dichtungen.com)

**dimensions of housing for model 01 - 08**

measurement schedule

C (mm)	A x 0,2
E (mm)	A x 0,5
b (mm)	H x 0,12

H (mm)	tolerance
up to 20	± 0,1
above 20	± 0,2

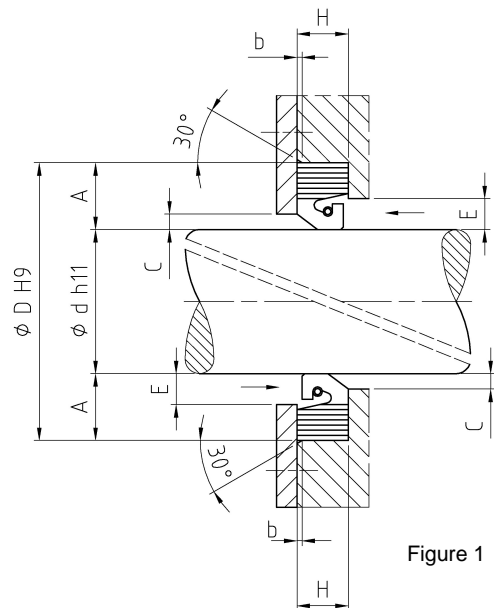

**dimensions of housing for model 10 - 11**

measurement schedule

d h8 (mm)	C (mm)	A (mm)	H (mm)	b (mm)
< 50	0,5	11	10 -0,1	1,2
50 ÷ 100	0,5	16	12,5 -0,1	1,5
100 ÷ 250	1	20	16 -0,1	2,0
250 ÷ 400	1	22	20 -0,2	2,2
400 ÷ 600	1	25	22 -0,2	2,5
> 600	1,5	32	25 -0,2	3,2

$E = A \times 0,5 \text{ (mm)}$

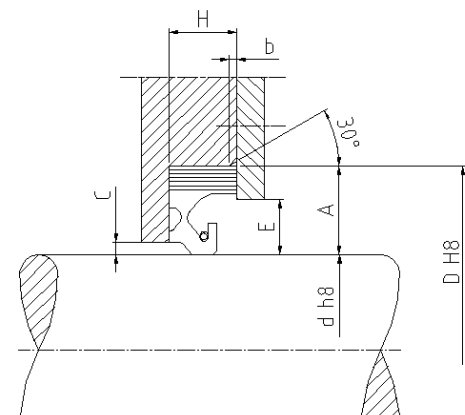

Figure 2

The data shown above is based on long lasting experience in the manufacturing and use of sealing elements. As there are many unknown possible parameters and conditions in practice, which may limit standard performance, it is requested that the user runs practical tests. Except as expressly stated, Friedrich's liability, expressed or implied, is limited to the published selling price of our defective item.

**FDI<sup>®</sup>** and **FDI-DICHTUNGEN<sup>®</sup>** are registered trademarks of Friedrich GmbH.

# Abmessungsliste FDI® - Wellendichtungen

## Size list FDI® - shaft seals

Typ / model: 01÷11

Maße Einbauraum  
Housing dimension

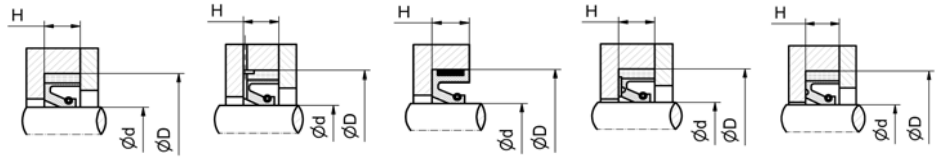

d	D	H	01 / 07	02 / 08	04	10	11
30	50	10			x		
38,1	60,4	12,7	x				
40	62	12				x	
45	62	10	x				
45	65	8			x		
50	72	12	x				
50	82	12,5	x			x	
55	75	10	x				
55	80	11	x				
60	74	8			x		
60	80	8	x				
60	80	11	x				
60	85	11	x				
60	92	12,5	x				
62	80	8			x		
65	80	8			x		
65	85	10	x				
65	85	12	x		x		
65	90	11	x		x		
65	97	12,5	x				
70	85	8	x		x		
70	90	7	x				
70	90	10				x	
70	90	12			x		
70	95	12	x				
70	102	12,5	x				
75	95	13	x				
75	100	12	x		x		
75	107	12,5	x			x	
80	100	10	x		x		
80	100	12,5				x	
80	100	13			x		
80	105	12	x		x		
80	105	12,5		x			
80	112	12,5	x	x		x	
85	117	12,5	x				
90	110	10			x		
90	110	12			x		
90	110	13			x		
90	115	11		x			
90	115	12	x		x		
90	120	12	x				
90	122	12,5	x			x	
95	115	12	x		x		
95	127	12,5	x		x	x	
100	115	90	x				
100	120	13	x		x		
100	125	12	x			x	
100	125	13	x				
100	130	12	x	x	x		
100	130	15					x
100	132	12,5				x	
100	140	16	x	x		x	
105	130	12	x		x		x
105	130	13				x	
105	145	16	x				
110	126	9	x				
110	130	9				x	
110	130	12	x		x		
110	135	12	x				
110	135	12,5					x
110	140	12	x		x		
110	150	16	x			x	
112	142	15,2			x		

# Abmessungsliste FDI® - Wellendichtungen

## Size list FDI® - shaft seals

Typ / model: 01÷11

Maße Einbauraum  
Housing dimension

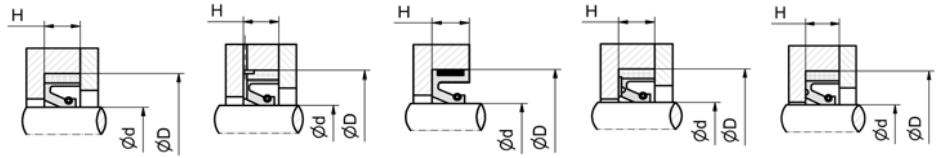

d	D	H	01 / 07	02 / 08	04	10	11
114	140	13,3	x		x		
115	137	8,8	x				
115	140	12	x		x		
115	140	13				x	
115	145	15			x		
115	150	15	x		x		
115	155	16			x		
118	140	14			x		
120	140	12,5	x		x		
120	150	13	x		x		
120	150	15	x				
120	155	15	x		x		
120	160	12	x			x	
120	160	16	x	x	x	x	
123	155	15				x	
123,8	158,7	14,3	x				
125	150	12			x		
125	155	12			x		
125	160	15	x				
125	165	16	x	x		x	
130	150	10	x		x		
130	150	12	x				x
130	155	10			x		
130	155	15,5	x				
130	160	12	x		x		
130	160	15	x		x		
130	165	13			x		
130	170	16	x		x	x	
133,3	171,4	15,8	x				
134	169	15			x		
135	157	8,8	x				
135	160	12	x				
135	165	13			x		
135	167	12,5				x	
135	170	13	x				
135	175	16	x			x	
136,5	161,9	15,9	x				
139,7	165,1	12,7	x		x		
139,7	171,5	15,87			x		
140	155	10	x				
140	160	13	x		x		
140	170	15	x	x	x		
140	180	16	x	x	x		
143	165	10			x		
145	170	13	x				
145	175	15	x				
145	180	14			x		
150	180	12			x		
150	180	13	x		x		x
150	180	15	x		x		
150	190	16	x		x	x	
155	180	12	x				
155	180	12,5	x				x
155	180	15	x				
158,7	182,7	16	x				
158,7	190,5	15,9			x		
160	190	15	x		x		
160	190	16	x		x		
160	200	16	x	x	x	x	
161,9	187,3	12,7	x				
165	190	15			x		
165	205	16	x				
165,1	215,9	15,8	x				
168,3	206,4	17,5			x		

# Abmessungsliste FDI® - Wellendichtungen

## Size list FDI® - shaft seals

Typ / model: 01÷11

Maße Einbauraum  
Housing dimension

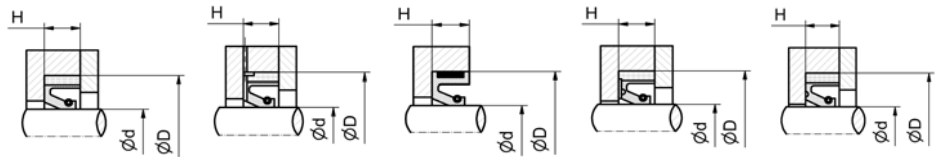

d	D	H	01 / 07	02 / 08	04	10	11
170	192	10,7	x		x		
170	200	12	x	x			
170	200	15	x		x	x	
170	210	16	x				
170	210	20	x				
170	220	15	x				
175	200	15	x				
175	205	15	x				
175	215	16	x		x		
177,8	203,2	15,8			x		
177,8	209,5	15,8	x		x		
177,8	215,9	15,9			x		
177,8	215,9	19,05	x				
180	200	15	x				
180	210	12	x		x		
180	210	15	x	x	x		
180	215	15	x				
180	220	16	x	x	x	x	x
185	229	20	x				
190	220	15	x	x	x		
190	220	16	x		x		
190	230	16	x			x	x
192	232	16	x				
195	220	15	x				
195	235	16	x		x		
200	225	15	x				
200	230	15	x		x	x	
200	231,8	15,9	x				
200	235	18,2	x				
200	238,1	19	x		x		
200	240	15	x				
200	240	16	x	x	x	x	
200	240	18				x	
200	250	18			x		
205	245	16	x		x		
207	247	15					x
210	240	15	x				
210	250	16	x	x	x	x	
215,9	266,7	19			x		
216	254	19	x				
220	250	12	x				
220	250	15	x	x	x	x	
220	250	16	x				
220	260	16	x	x	x		
220	270	16	x				
225	270	16	x				
226	258	16			x		
228,6	260,3	15,8			x		
230	260	15	x				
230	260	16	x				
230	270	16	x		x		
230	270	20	x				
230	280	16	x				
230	280	23		x			
235	270	18			x		
235	275	20			x		
240	270	13,5				x	x
240	270	15	x	x			
240	270	17	x				
240	280	16	x	x	x	x	
245	270	13	x				
248,3	288,3	16	x				
250	280	15	x				
250	280	16	x		x	x	x

# Abmessungsliste FDI® - Wellendichtungen

## Size list FDI® - shaft seals

Typ / model: 01÷11

Maße Einbauraum  
Housing dimension

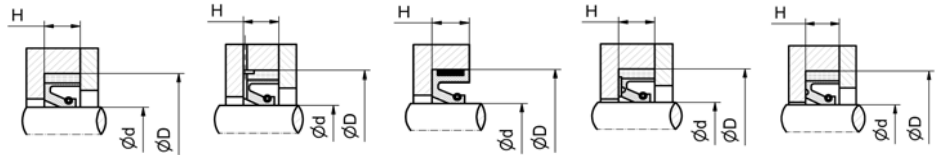

d	D	H	01 / 07	02 / 08	04	10	11
250	280	19	x				
250	281,7	12,7	x	x			
250	290	16	x		x	x	
250	303	20	x				
254	279,4	14,3			x		
255	299	20	x				
258	288	15	x				
260	290	16	x				
260	298	17	x				
260	300	16	x				x
260	300	18	x			x	
260	300	18,3					x
260	300	20	x		x		
260	304	20	x	x	x		
265	300	16		x			
265	310	16	x				
266,7	311,15	19,05	x				
270	300	15	x				
270	310	16	x		x		
270	310	20	x				
270	314	20	x				x
274,8	320	16	x				
275	310	15	x				
275	315	20	x				
279,4	317,5	15,8			x		
280	310	15	x				
280	310	16	x				
280	320	16	x	x		x	
280	320	18	x		x		
280	320	20	x		x		
280	324	20	x		x		
284	328	16	x				
285	325	16			x		
285	325	18		x			
285	329	20	x				
285,7	323,8	19			x		
290	330	18					x
290	330	20	x				
290	334	20	x	x	x		
290	335	20	x				
295	325	15	x		x		
295	339	20	x				
295,27	333,37	19,05	x				
300	332	15	x				
300	332	16	x				
300	340	16	x	x			
300	340	20	x		x		
300	344	20	x		x	x	x
300	344	22	x				
305	340	15	x				
305	349	20	x				x
310	350	16	x				
310	350	18	x	x	x		
310	354	20	x				
310	355,6	20					x
315	355	20	x				
315	359	20	x				
315	360	20	x	x			
317,5	355,6	19	x				
317,5	368,3	19,05	x				
320	350	15	x				
320	355	16		x			
320	360	18	x				
320	360	20	x		x		

# Abmessungsliste FDI® - Wellendichtungen

## Size list FDI® - shaft seals

Typ / model: 01÷11

Maße Einbauraum  
Housing dimension

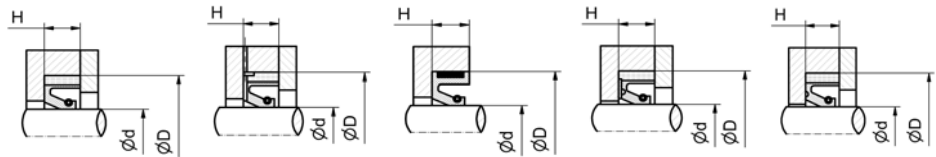

d	D	H	01 / 07	02 / 08	04	10	11
320	364	20	x				x
320	365	16	x				
323	363	16	x				
323,85	374,65	19,05	x				
325	369	20	x				
330	370	18	x				
330	370	20	x				
330	374	20	x				
340	380	20	x		x		
340	384	20	x	x		x	x
346	390	20	x				
348	380	16			x		
350	390	16	x				
350	390	18			x		
350	390	20	x		x		
350	394	20	x				
355	393	19,05	x				
355	394	20	x				
355,6	393,7	17,4			x		
360	400	20	x		x		
360	404	20	x			x	
365	405	18	x		x		
365	409	20	x				
370	410	18	x				
370	414	19	x	x	x	x	
370	414	20	x				
374,6	419,1	19			x		
375	420	16	x				
380	420	15	x		x		
380	420	20	x			x	
380	424	20	x				
384	414	15			x		
385	425	18	x				
385	429	20	x				
390	420	14	x				
390	420	16	x				
390	430	20	x				
390	434	20	x	x			
395	430	18	x				
400	425	12,7			x		
400	440	20	x	x	x	x	
400	444	20	x	x	x	x	x
400	450	22	x	x			
405	455	22	x		x		
406,2	444,5	17,5		x			
406,4	457,2	28,6	x				
410	450	20			x		
410	460	22	x				
420	460	18		x			
420	460	20	x				
420	470	20	x				
420	470	22	x	x			
430	474	20	x				
430	474	22	x				
430	480	20	x				
435	485	22	x				
440	480	20	x		x		
440	490	22	x	x	x	x	
440	490	28		x			
450	494	20	x				
450	500	20	x				
450	500	22	x				x
454	500	18	x				
455	505	22		x			

# Abmessungsliste FDI® - Wellendichtungen

## Size list FDI® - shaft seals

Typ / model: 01÷11

Maße Einbauraum  
Housing dimension

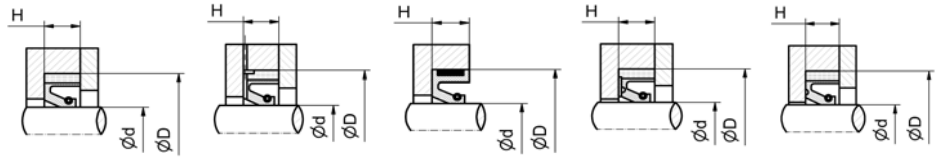

d	D	H	01 / 07	02 / 08	04	10	11
457,2	508	20,6	x				
458	494	12			x		
460	485,4	12,7			x		
460	500	20	x		x		
460	510	22	x				
470	520	22	x				
475	530	20	x				
477	527	22		x			
478	530,2	19,1					x
480	520	16	x				
480	520	20	x				
480	530	22	x				
485	535	22	x				
490	540	22		x			
495	545	25		x			
497,5	546	22	x				
500	540	20	x	x			
500	550	20	x				
500	550	22	x	x		x	
503	552	20	x				
515	565	22					x
520	560	14,7	x				
520	570	19	x				
520	570	22	x				
525	569	20	x				
525	575	22	x				
530	570	22		x			
530	580	20	x				
530	580	22	x		x		
540	590	22	x				
540	590	25	x				
542	578	18	x				
550	600	22	x		x		
555	605	22		x			
560	610	22	x				
570	620	22	x	x			
580	630	22	x		x		
584,2	635	22	x				
584,2	647,7	25,4	x				
590	640	22	x				
590	640,8	22		x			
600	640	20	x	x			
600	650	22	x				
600	650,8	22,2	x				
600	664	25		x			
609,6	660,4	22,2	x				
620	660	20	x				
620	670	22	x				
634,9	685,7	22,2	x				
650	700	22		x			
650	714	25	x	x			x
660	724	25	x				
665	729	25	x				
670	735	25	x				
680	744	25	x				
685	749	25	x				
690	754	25	x				
700	764	25	x	x			
710	760	20	x				
710	774	25		x			
730	794	25	x				
740	804	25	x				
744	808	25	x				
750	814	25	x	x			

# Abmessungsliste FDI® - Wellendichtungen

## Size list FDI® - shaft seals

Typ / model: 01÷11

Maße Einbauraum  
Housing dimension

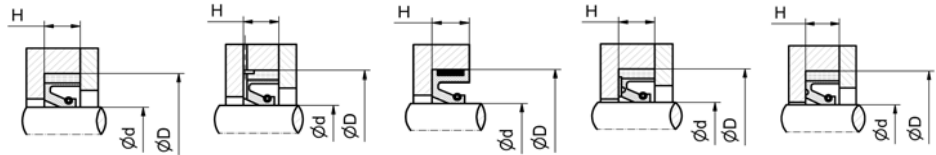

d	D	H	01 / 07	02 / 08	04	10	11
761,9	825,4	25,4	x				
780	844	25	x				
810	860	25	x				
832	870	19	x				
850	914	25	x				
890	954	25	x				
900	964	25	x				
920	984	25	x				
930	994	25					x
960	1024	25			x		
1020	1084	25	x				
1054,1	1105,1	22	x				
1055	1119	25		x			
1103	1153,7	22	x				
1200	1264	25	x				
1302	1353	22	x				
1420	1484	25		x			
1450	1514	25		x			
1880	1944	25		x			
1890	1954	25		x			